



Artisan Scientific

QUALITY INSTRUMENTATION ... GUARANTEED

Looking for more information?

Visit us on the web at <http://www.artisan-scientific.com> for more information:

- Price Quotations
- Drivers
- Technical Specifications, Manuals and Documentation

Artisan Scientific is Your Source for Quality New and Certified-Used/Pre-owned Equipment

- Tens of Thousands of In-Stock Items
- Hundreds of Manufacturers Supported
- Fast Shipping and Delivery
- Leasing / Monthly Rentals
- Equipment Demos
- Consignment

Service Center Repairs

Experienced Engineers and Technicians on staff in our State-of-the-art Full-Service In-House Service Center Facility

InstraView™ Remote Inspection

Remotely inspect equipment before purchasing with our Innovative InstraView™ website at <http://www.instraview.com>

We buy used equipment! We also offer credit for Buy-Backs and Trade-Ins

Sell your excess, underutilized, and idle used equipment. Contact one of our Customer Service Representatives today!

Talk to a live person: 888-88-SOURCE (888-887-6872) | Contact us by email: sales@artisan-scientific.com | Visit our website: <http://www.artisan-scientific.com>

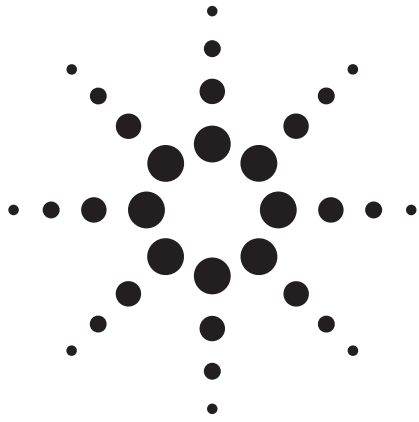

Agilent TS-5400 Series II

Automotive Electronics Functional Test System

Product Note

Test Engineering Challenges

On time test deployment within budget is your department's responsibility. To accomplish this, the test system utilized must provide adequate test coverage and test times while ensuring the manufacture of quality products. In developing a test platform, you must balance three competing goals: **time** (test development, execution and system deployment); **cost** (capital and integration); and **scope** (throughput, accuracy and flexibility) [see Figure 1]. Competing in today's automotive electronics manufacturing environment means using reusable, scalable test platforms that meet the evolving test requirements of electronic control modules and smart sensors.

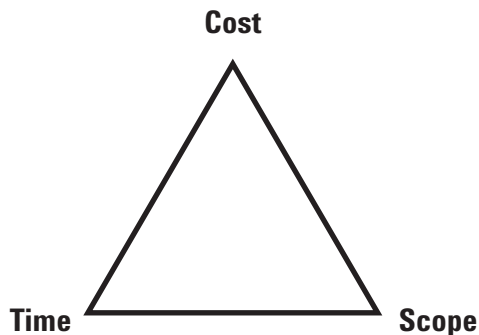

Figure 1: The Balancing Challenge

There are three approaches to choose from when creating a test system: use your in-house test department to build your own, outsource the development of the entire system, or use a commercial off-the-shelf platform as the basis for the test system to be deployed. The Agilent Technologies TS-5400 Series II is a commercial, off-the-shelf platform tuned specifically for automotive electronics functional test.

Measurements in Electronic Control Modules (ECMs) are challenging today, and new developments for engine management systems, powertrain control, safety, security and convenience modules promise to make them even more challenging down the road. This platform facilitates test strategies for ECMs in current production with the ability to adapt to a wide range of possible ECMs in future production. What's more, users of the TS-5400 Series II have reported **time-to-market improvements of 300%**.

Manufacturing Goals

Producing quality ECMs faster and at a lower cost than the competition, without compromising test coverage, can be an overwhelming challenge in the fast-paced automotive electronics industry. In exploring the three competing goals [see Figure 1], the need to focus on each individually, while simultaneously studying how they relate to one another, becomes increasingly clear. Meeting the tremendous deadline pressure to get manufacturing test lines set up on **time** requires test engineering to perform faster test development, execution and line integration. In turn, increasing throughput to decrease the test **cost** per ECM requires faster test execution while maintaining a high level of test coverage. And finally, test coverage and capability depend on the flexibility in the **scope** of the test system to accommodate the rapid introduction of new convenience, security, safety and engine management ECMs.

Achieving the proper balance among all three goals is difficult yet necessary for manufacturers to better meet OEM timelines. In an effort to find this



Agilent Technologies

balance, where time is the ultimate constraint, manufacturers are forced to make decisions on trading test coverage for maintaining a lean time-to-market. Or, manufacturers are forced to make decisions on trading wide ranging, flexible ECM test capability for module-dedicated test systems – a poor use of assets in the long term. Making a decision between issues of quality and test system capabilities is a choice no manufacturer should have to face. That’s why Agilent is pleased to introduce a competitive new test system that lets you have it all: quality test coverage, lower test **cost** per ECM and flexibility in **scope** – all at a faster **time** to market.

The Agilent Solution

The TS-5400 Series II automotive electronics functional test system helps manufacturers get their products to market faster by accelerating test system deployment. Engineered with the three critical manufacturing goals in mind, this family of platforms provides flexibility, speed and quality to automotive electronics production. When it comes to flexibility, a universal test system core of both hardware and software can easily be modified to suit your particular test strategy and range of ECMS. As for speed and quality, an enhanced test executive accelerates both the development and execution of tests with over two hundred automotive applications-tuned libraries.

Four base platforms test the range of automotive ECMS. From simple ECMS, like climate control, immobilizers and RKE (remote-keyless entry), to safety ECMS such as airbag and ABS/TC to complex ECMS like engine management systems, the TS-5400 Series II meets the price/performance required. These platforms [see Figure 2] are tuned for automotive electronics functional test and consist of measurement resources, switching, a test executive and automotive tuned library routines. Racking, cabling and optional fixturing are included, as well as standard software development tools that enable test engineers to deploy test systems **up to three times** faster than building test systems from individual components.

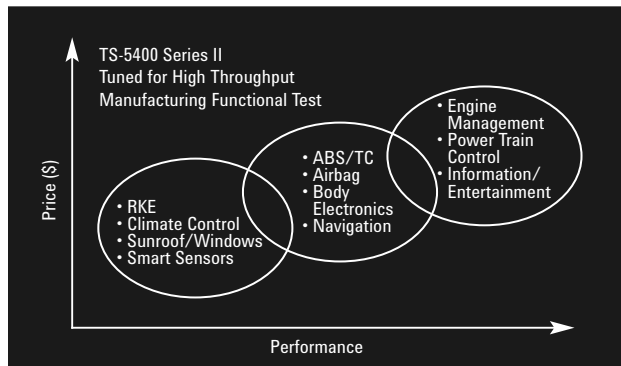

Figure 2: The TS-5400 Series II Tests the Range of ECM Complexity/Pin-Count

Just Enough Test

With the growth in convenience and safety ECMS, test engineering needs to meet the production throughput goals at a cost of test that remains competitive in today’s market and tomorrow’s. The measurement envelope for convenience ECMS is not as demanding as those for safety and engine management systems. Recognizing this, the TS-5400 Series II comes in two powerful configurations to meet the given ECM test requirements [see Figures 3 & 4].

As a result of the TS-5400 Series II unique architecture, you can now purchase **“Just Enough Test”** resources to meet current ECM test requirements, then add test capabilities to the system when new ECMS move into production.

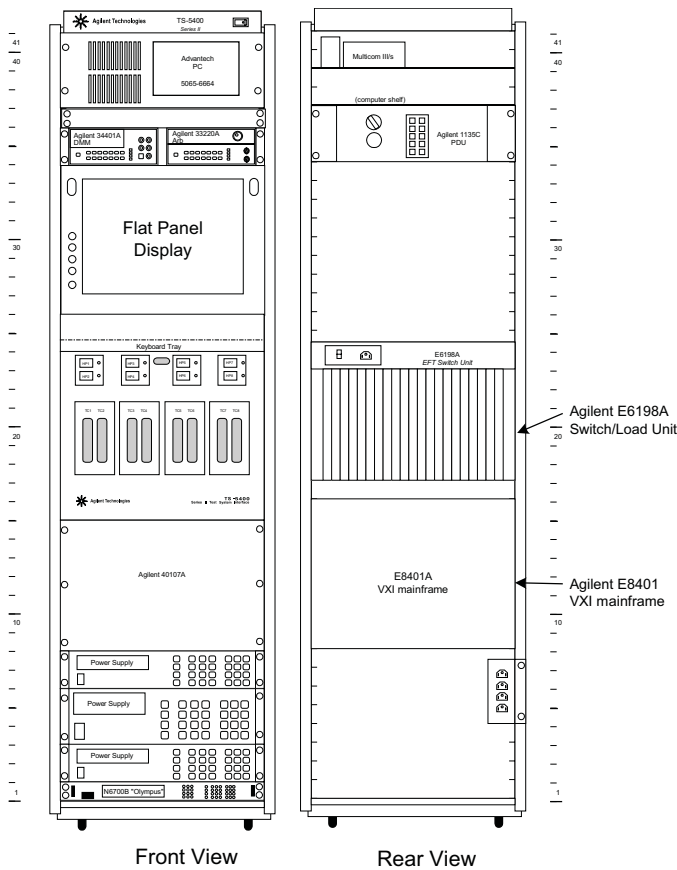

Figure 3: VXI/GPIB Express Connect (front and rear views)

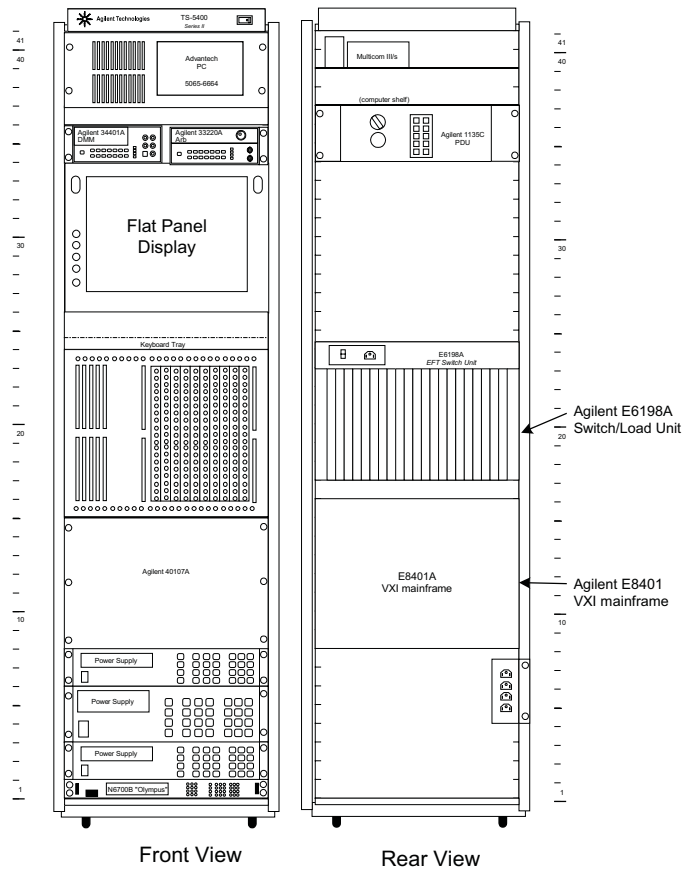

Figure 4: VXI/GPIB Mac Panel (front view and rear views)

TS-5400 with Express Connect Interface – Medium-to-High Pin Count Application

For the medium to high pin-count/complexity ECMs, the measurement engine is VXIbus-based with a DMM, Measurement Control Module (MCM), Event Detector, Arbitrary Function Generator (ARB), Digitizer, Counter, and other optional VXI-based instrumentation. Optional GPIB instruments may be configured. As in the low pin-count/complexity ECU platform, all switching (instrumentation, power supply and load) resides in the Switch/Load Unit. The Express Connect Interface [see Figure 3] consists of one Switch/Load Unit. This system uses the IEEE-1394 FireWire for VXI I/O and GPIB for all IEEE-488 instruments (power supplies and additional optional message-based instruments).

TS-5400 with Mac Panel Interface – High Pin Count Application

This high-performance throughput system uses the MXI-II interface for the VXIbus I/O. It's a platform that yields 5% greater throughput; valid on high-end ECMs [engine control/management modules and powertrain control] when the highest tester throughput is desired.

All the test platforms use an enhanced version of TestExecSL. The latest version of the test executive software allows for faster test plan development, easier integration of message-based instruments (adding VXI or GPIB optional instruments) in addition to the ability to support test plans from the Agilent TS-5400 Series I. The optional "Throughput Multiplier" for simultaneous testing of multiple modules or Units Under Test (UUT) is also available.

Throughput Multiplier

The Throughput Multiplier test strategy (multiple-up UUT testing) is one way to increase throughput for a manufacturing environment. Multiple UUT testing not only consolidates tasks common to multiple modules, such as load/unload, instrument set up of signal and load routing, it's also an effective strategy for overlapping inherent latencies in the UUT or test system [see Figures 5 and 6].

Testing

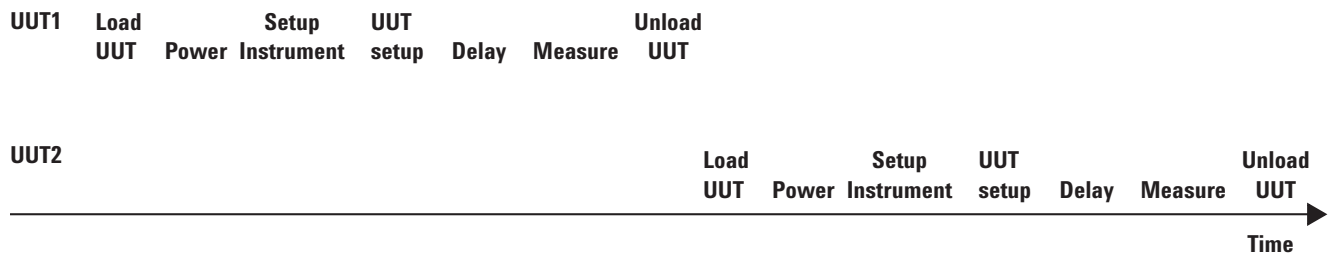

Figure 5: Single-Up UUT Testing

Testing

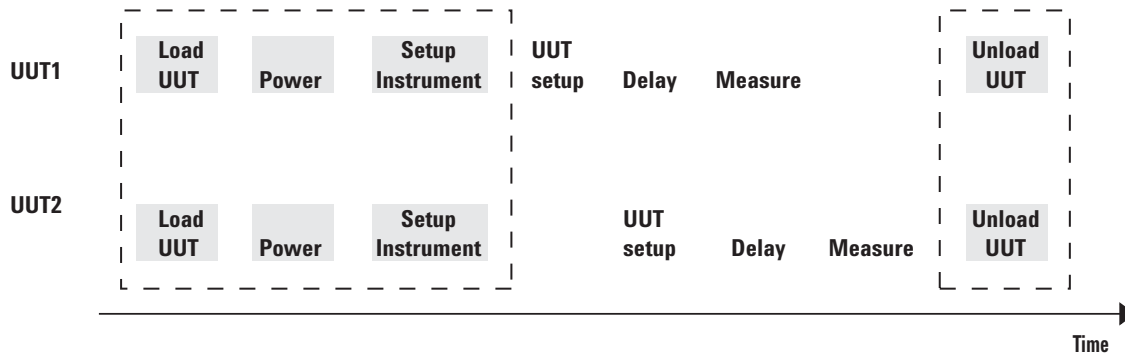

Figure 6: Multiple-Up UUT Testing

Test Requirements and Methodologies

Serial

Most ECM designs include a serial interface as shown in Figure 7. Communication protocols vary by manufacturer, but most comply with OBD2 standards. Variations include ISO-9141, J1939/CAN and J1850. The serial link is used in the automobile itself, but can also assist in the testing of the module. Test code (as opposed to operational code) is either included in ROM or downloaded through the serial link into the module. Operational code is either present in ROM during test or is downloaded when the unit is shipped. Using test code routines as part of the test program, the test system establishes a set of conditions to which the ECM responds. This test approach is called **UUT-Assisted Test**.

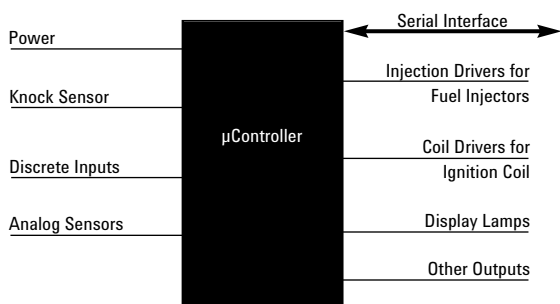

Figure 7: Serial Interface for Engine Control ECM

UUT-Assisted Test

For clarity, consider three different modes for performing UUT-Assisted Test. The mode chosen will be defined by the test stimulus source and response destination.

Serial Link Evaluation: This first mode simply evaluates the serial link and microcontroller. Commands received by the microcontroller over the serial link prompt a serial response that is sent back to the test system. The system then verifies the response and it may follow with a full CRC memory check. Parametric tests may also be run to test the serial link's characteristics, such as delay, rise and fall times, and input impedance.

I/O Status Evaluation: This mode uses the test system I/O to determine the ECM input states. This is accomplished by sending a message over the serial link to the ECM prompting it to run one of its loaded test routines. For example, use of this mode may occur when supplying an analog input into the system to verify the A/D conversion and the controller's handling and communication of the proper (hex) data over the serial link. Specifically, this analog input may be a simulation of a sensor's output for air or water temperature, the Throttle Position Indicator (TPI), Manifold Air Pressure (MAP) and the like. This mode illustrates how UUT-assisted testing allows the test system to assess proper functioning of several functions at once—including the controller and serial link. In addition, the system can assess the A/D and waveform processing circuitry.

Input Evaluation: The final mode involves the test system supplying input, then reading the value at either the input or output of the module. For example, this would include dynamic tests such as the application of a cam/crank phase synchronous waveform, (MAP or TPI input). This evaluation would verify if the signal is read correctly at the input of the module or if the given signal prompted the appropriate response at the module's output.

What Makes Automotive Functional Testing Unique

Testing of automotive ECMs requires an understanding of the key characteristics in design and manufacturing. What follows is a description of the general requirements for testing an automotive ECM (using an engine control module as the unit under test). Next, you will find an overview of the TS-5400 Series II system architecture illustrating its benefits as a functional test solution for automotive electronics.

Characteristics of Testing Engine Management ECMs

The Agilent TS-5400 Series II Solution

Fast Switching for Multiple Signal and Load Routing

- Programmable Switch/Load Unit
- Multiple Load Card Capabilities with Fast Relays
- 42V Ready Solution
- Pull-Up and Pull-Down Load Capabilities
- Bridge Load Capabilities

“Real World” Waveform and Signal Generation

- Variable Reluctance and Hall-Effect Sensor Simulation
- Knock Signal Simulation

High Current/Voltage Response Handling

- Flyback Voltage/Current Handling
- Voltages up to 500V, Currents up to 30A
- Period, Frequency, Timing and Duration Measurement Capabilities

Serial Communication

- ISO-9141 Capability
- J1850 Capability
- J1939/CAN Capability

Requires High Throughput (<20s for 100 pin-count ECM)

- Optimized Software (fast sequences, pre-compiled tests, state tracking)
- Fast (0.5ms) measurement matrix relays

Table 1: Engine Control ECM Testing Characteristics and the TS-5400 Solution

Testing engine management system ECMs presents the most difficult challenge for today's automotive electronics test systems. These modules require a dynamic range of both stimulus and response signals with flexible loading, high-speed, high-resolution measurements and comprehensive serial communication capabilities. In fact, many of today's systems require two minutes or more to test a single, 100-pin module. Engineered with the unique challenges of automotive electronics testing in mind, the TS-5400 Series II reduces this time to twenty seconds, thus increasing production volume while greatly reducing the cost of test. In short, developers of the TS-5400 Series II are committed to helping customers create the greatest quantity of quality electronics in the shortest time possible – all at the best price/performance possible.

The first four sample tests listed provide assurance to continue with the elements of dynamic testing such as fuel injection pulse timing and width, coil flyback voltage, spark advance behavior under MAP, TPI and knock signal input of variable amplitude.

For other modules, the Power Up, Analog Sensor Input, Input Pin Parameter and Output Pin Parameter tests would be similar in nature, while the dynamic tests may vary. Engineered to empower manufacturers in their choice of module classes, the flexibility of the TS-5400 Series II allows you to introduce a variety of measurement envelopes to meet a given module's testing needs.

Sample of Tests for Engine Control ECM	Sample Measurements
Power Up	<ul style="list-style-type: none"> • Input Current • Input Capacitance
Analog Sensor Input	<ul style="list-style-type: none"> • Response to Analog In
Input Pin Parameter	<ul style="list-style-type: none"> • Input Bias • Clamp Voltage • Leakage Current • Pull-Up Loads • Pull-Down Loads
Output Pin Parameter	<ul style="list-style-type: none"> • Saturation Voltage • Leakage Current • Flyback Voltage • Smart Driver Timing • Duration of Flyback
Dynamic	<ul style="list-style-type: none"> • Spark Advance (MAP, TPI varying) relative to TDC • Timing and Width of Fuel Injection Pulses

Table 2: Sample Tests and Measurement for an Engine Control ECM

The Agilent TS-5400 Series II Architecture

The TS-5400 Series II is designed to help accelerate test system deployment while ensuring quality measurements at an industry leading uptime. The overall TS-5400 Series II architecture [see Figure 8] consists of a Windows NT based controller running TestExec SL software with hundreds of pre-tested automotive-tuned library routines. The controller is connected to the primary Switch/Load Unit (SLU) via parallel interfaces (additional SLUs may be configured by extender cables from the primary SLU). The controller is also connected to the instrument set, including power supplies, through a GPIB interface (for IEEE-488 instruments) and a high-speed interface (for VXIbus-based instruments) and RS-232 (for ODB2 serial).

21-Slot Switch/Load Unit

The true core of the platform lies in the Switch/Load Unit. The programmable Switch/Load Unit is used for instrumentation switching (GPIB, Serial or VXIbus-based), plus switching power supply and loads to the ECM. Test system resources (instrumentation, loads and power supplies) are routed to the UUT through the Pin Matrix cards and load cards that plug into the Switch/Load Unit. There are four types of load cards and two types of pin matrix cards.

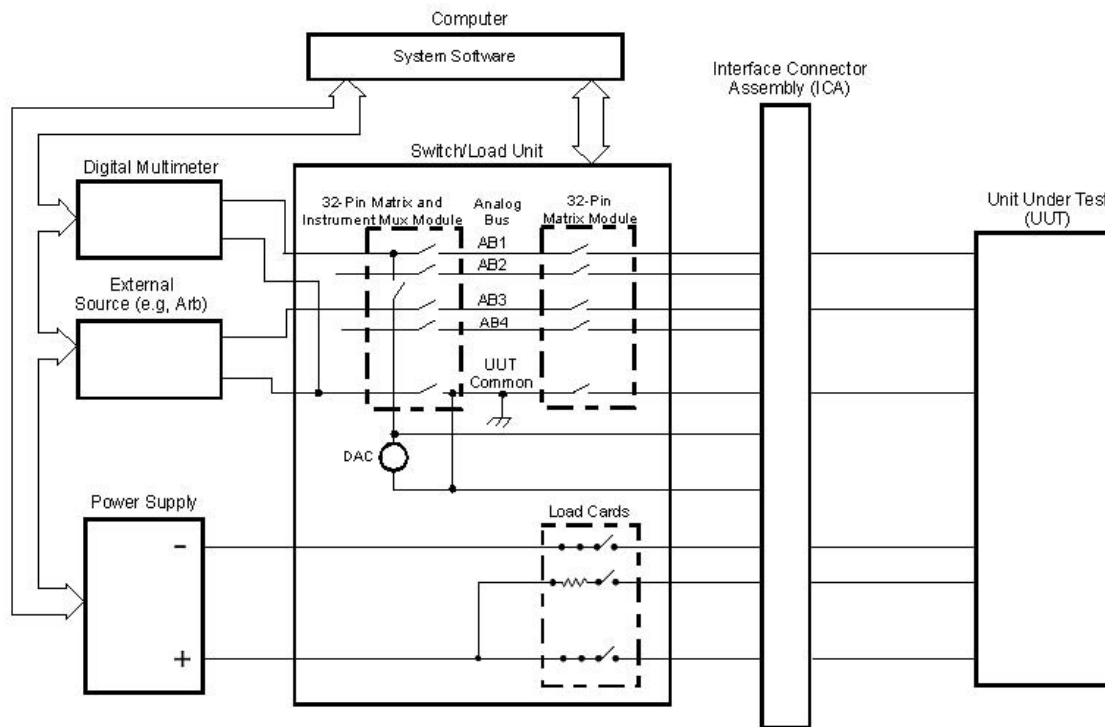

Figure 8: System Architecture for the TS-5400 Series II

Load Cards

In an automotive electronic system there are many special load requirements, from simple resistive loads to highly inductive loads (such as the ignition coil). In many cases it's crucial to simulate the load, while in others an actual load is used to gain accurate visibility into the performance of the UUT. The Switch/Load Unit is designed with a flexible load topology capable of meeting either load strategy. The four types of load cards are described in Table 3. Provisions to measure the current through any load channel have been designed with sense resistors available on the 8- and 16-channel load cards.

Pin Matrix Cards

These cards consist of a 32x5 matrix, which provides fast connections into or out of the system for 32 rows into 4 columns (the fifth column is UUT ground). The four columns are collectively referred to as the A-Bus. The matrix has a 0.5ms switching time, ~60 times faster than standard off the shelf VXIbus-based matrix switches (20-30ms).

High reliability switching (typically 108 cycles) is assured through jumper removable protection resistors on the card. Additional pin matrix cards may be added to increase the system pin-count capabilities. The E8792A is a 4x16 matrix with an additional line for UUT Common. These four channels can be routed to 32 pins on the UUT. Disconnect relays allow you to build large matrices (>150 pins) without degradation. For applications requiring more than 32 channels, the E8793A Pin Matrix card (without the 4x16 instrument matrix) may be used for increasing channels in increments of 32. The A-bus is daisy-chained from card to card to route the 16 instruments to N*32 channels, where N represents the number of Pin Matrix cards including the E8792A. Automatic switching permits a simple programming model.

Custom Card

With the custom card, test engineers are assured compatibility when using the TS-5400 Series II. In addition to that, should test engineers require custom circuitry, the custom card may be used as a breadboard. The card is also useful in Express Connect systems for routing of auxiliary relays.

Load Card	Features
E6178A 8-Channel Heavy Duty	<ul style="list-style-type: none">• 30A continuous, 200A Surge Capabilities• Engineered for Applications from Antilock Brake Systems to Engine Control and other Motor Applications
E6175A 8- and E6176A 16-Channel	<ul style="list-style-type: none">• Current Sense Capabilities• 7.5A Continuous, 15A Peak• High Current Protection Circuitry• Engineered for High Voltage Flyback Inductive Load Applications
E6177A 24-Channel	<ul style="list-style-type: none">• Good for Resistive Loads, Pull-Up, Pull-Down and Bridge• Good for Medium Current Applications, Up to 2A

Table 3: Load Card Type and Features

Measurement Control Module (MCM):

This powerful card contributes to the versatility of the system's capabilities, providing its own 4x16 matrix to fan the four columns into 16 separate instruments. Twelve of these lines are set up in default configuration for the Counter, 2-channel isolated Arbitrary Waveform Generator, Digitizer, and DMM. The MCM card adds other important capabilities to the system as well. For example:

- Connects any pin to any resource
- Four quadrant V/I $\pm 16V/200mA$, $\pm 100V/20mA$
- Provides isolated programmable voltage or current source with internal wiring for measurement of current or voltage, respectively
- Programmable attenuator allows one-cycle saturation and flyback voltage measurement
- Amplifier amplifies signals from the Waveform Generator to ± 80 volts; useful when simulating speed sensitive VRS (Variable Reluctance Sensor) signals
- Amplitude-dependent attenuation of incoming signals for digitizing
- Sophisticated, bi-directional trigger routing scheme; 19 trigger inputs may be routed to any of 19 trigger outputs
- Triggers can be routed over VXI backplane to UUT
- Triggers can be routed through timer created pacing, watchdog or trigger delays
- Programmable UUT reference comparator allows the UUT to generate threshold triggers for synchronous instrument measurements

Mass Interconnect:

The switching interconnects via the mass interconnect to the Unit Under Test [UUT]. The Mass Interconnect consists of an Interface Connect Assembly (ICA) and an Interface Test Adapter (ITA), each having its own connector blocks and matching pins [see Table 4]. To meet test engineers' demand for flexibility the TS-5400 Series II allows you to use the Agilent supplied standard mass interconnect or a user's custom design. The two Agilent supplied mass interconnects are the MAC Panel, and Express Connect. The ICA is mounted to the system rack and both Agilent supplied ICAs feature a hinged insert that, when released, allows the panel to fold down 90° away from the system. This design allows convenient access to the wiring,

Pin Matrix and Load Cards. The ITA inserts into the ICA and locks in place.

Table 4: System Configurations

Key Components of the Express Connect & Mac Panel Interfaces	Optional GPIB & VXI Instrumentation with TS-5400 Series II Action Sets
E1411B Digital Multimeter (DMM)	• E6172A VXI bus-based Pin Matrix
E6171B Measurement Control Module	• E6173A Arbitrary Dual Channel Real Time Arbitrary Waveform Generator • 33220A GPIB 20 MHz Arbitrary Waveform Generator
E6198A 21-Slot Switch/ Load Unit	• E6174A Event Detector
E8792A Pin Matrix Card	• E6181A Digital to Analog Converter
E8793A Pin Matrix Card for added channels; standard on the Express Connect & Mac Panel Interfaces	• E1333A VXI Counter & 53131A GPIB Universal Counter • E1418A 8-Channel Non-isolated Digital to Analog Converter (DAC) • E1563A Dual Channel 800kHz Digitizer

Note: Any GPIB or VXIbus-based instrument may be added to the system

Software Increases Productivity

Due to its advanced hierarchical software development environment, the TS-5400 Series II delivers maximum reusability. Software is further optimized for fast execution of each routine. This high quality, fully tested software consists of both developer and test-execution environments. The test system developer uses the hierarchical environment for creating the test program. Test Operators view a panel created by the test developer for conducting tests on specific modules. Agilent provides a sample operator interface that's easy to change or upgrade. Developers can also utilize Visual Basic® to quickly develop a custom operator interface.

More Than Just a Product— It's a Complete Solution

When you choose the Series II, you choose to maximize value with a complete solution offering. The TS-5400 Series II is much more than hardware and software tools. It's a complete system solution—product to services—that includes the following:

- System Documentation
- Application Consulting
- Customer Training
- Software Updates
- Cooperative Maintenance
- Extended Warranties
- Repair, Calibration, and Self Diagnostics
- Remote Support

This wide range of services lets you take advantage of the full value of the TS-5400 Series II. Documenting a system can be difficult when test engineering's primary focus is to keep production up and running. The TS-5400 Series II provides complete documentation of its unique capabilities: cabling, mass interconnect, power distribution and software. You need only worry about documenting and supporting the customization of the platform. Agilent also offers system platform training to augment its extensive curriculum of educational products. When it comes to hardware components and unique platform features, the Agilent team provides worldwide support. What's more, cooperative support arrangements can be made for optimal uptime of test systems.

Why Buy the TS-5400 Series II?

Depending on a manufacturer's production situation, there are numerous benefits to adopt the platform concept. Take a look at some of those benefits as they relate to one of your upcoming projects.

1. Reduce Test Development Time

Because the TS-5400 Series II is a pre-built system, representing the majority of a test system solution, it's never been easier to keep pace with demand. The software development productivity of the Series II results from a hierarchical approach to test development designed to maximize the reusable code in a structured process. The high quality software environment, tests, measurements, and utilities are a direct result of intensive design, while the unique platform approach saves steps in developing the complete system [see Figure 9]. Moreover, system design and planning steps are reduced as a result of pre-defined architecture. The system interconnections, cabling and racking are specific activities performed by Agilent, while test engineering focuses on the unique aspects of testing a given ECM. In addition, Agilent provides software documentation, training and support.

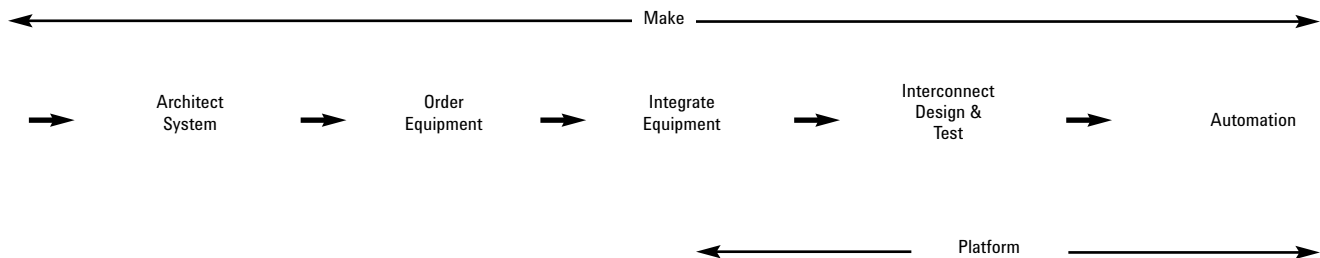

Figure 9: The TS-5400 Series II Streamlines Test Development Process to Speed Time-to-Market

2. Save Capital Costs

Running tests faster translates to less equipment and lower costs. The TS-5400 Series II test platform features an instrumentation set that allows Agilent to optimize throughput by tuning the hardware and software for fast execution. With no special effort or time expended, you can use the Agilent software routines for the fastest test times. The unique combination of multiple-up support, for testing more than one UUT at a time, and faster test times will reduce your capital costs.

3. Flexibility

Many manufacturing facilities require flexibility to keep pace with the dynamic changes in the automotive electronics manufacturing industry. New production lines are being deployed worldwide. Technologies are constantly changing, in addition to demands for new ECMs and features. As manufacturing requirements change in this ever-evolving market, it only makes sense that a flexible testing platform approach is better suited to meet your needs. The TS-5400 Series II includes four family members, all built with a common architecture and core. Software and hardware for testing ECMs is available, providing a common look and feel across production lines testing different ECMs. The modularity of the system platform lets you add the functionality you need to test the different versions and types of ECMs, while at the same time controlling automation and line integration.

4. Worldwide Deployment

Many companies are operating in a global business environment. For test departments, this sets the stage for a mixed bag of complications, including setting up new production lines in other countries. Typically, production lines are duplicated and local people are trained to run the manufacturing process. However, there's often a heavy burden imposed on the central test engineering department to support the test stands. Any software changes or questions concerning operation eventually make their way back to these already overburdened engineers.

Software and test systems may be difficult to troubleshoot and maintain, especially when test engineers have time and resource pressures. With the Agilent test platform approach, stable test results are readily achieved worldwide with extensive diagnostics tests that verify system functionality. Furthermore with standardized software, hardware and integration, Agilent Technologies can support the platform worldwide, while support for the integrated solution can be provided locally. Finally, cooperative support between Agilent and the manufacturing site provides maximum uptime.

5. Built-in Growth Path

More often than not, test stands are created in a schedule-driven environment. It's difficult to take the time to design and create a system that can be upgraded and leveraged for an extended period of time. Test plans written on a deployed TS-5400 Series I will run on any of the TS-5400 Series II platforms today and into the future, provided the platform contains the same measurement core. The test plans will execute without changes.

TS-5400 Series II upgrades are most often driven by the need for additional features, measurement capability or more automation. This built-in upgrade path not only preserves your initial investment, it offers the flexibility to grow to a multi-up tester and/or add the latest instruments and computers. In other words, you can start with the TS-5400 Series II configuration that meets your current needs, then upgrade the configuration as production volumes increase or versioning of the ECM requires additional instrumentation. The results? Longer useful life of test systems, as well as a reduction in start-up risks.

6. Reduce Total Test Cost

Test cost is only one factor in reducing the total cost of manufacturing an ECM; however, it's a tangible cost that can be reduced by test engineering. To reduce test costs, test engineers focus on reducing test times, equipment costs and floor space. The TS-5400 Series II answers the call by delivering reduced integration costs, floor space and test times.

With the volume increase in safety, security and convenience modules, manufacturers are looking for ways to meet their line-production rates without building up inventory on the production line. Using the Throughput Multiplier for parallel multiple-up testing of ECMs not only reduces floor space and increases asset utilization, it decreases test times per ECM.

Most electronics manufacturers insist that their biggest test costs are tied directly to the instrumentation hardware. But that may not be the case. Hidden costs of software engineering time, operating costs and maintenance expenses must also be considered in the cost equation. Operation costs include management, facilities, and the skilled personnel needed to run the test systems. With a standard platform of hardware and software, support and training costs are lower than that of a one-of-a-kind system.

System Software Reduces Development Time

The TS-5400 Series II software provides a complete test development and test execution environment for the entire software development job. The test executive environment is tuned for functional testing of electronic devices in manufacturing. The software runs on a PC with Windows NT 4.0 for optimum performance. Plus, it's all pre-installed and ready to use. The TS-5400 Series II software development environment is ideal for creating ECM functional test plans. It consists of re-usable tests, measurements and utilities for performing specific functions related to automotive electronics functional test. Templates and examples are provided to serve as a starting point for creating tests. The Agilent test executive allows you to organize and order tests, reconfigure the test stand, profile the execution speed and debug tests. What's more, the software test execution environment allows an operator to test up to N modules simultaneously (where $N > 1$) and report test information back to the operator. Using the software utilities, the test executive can be easily linked with factory automation, bar code readers and printers.

The Agilent TS-5400 Series II Software Development Environment

The hierarchical test development architecture encourages reuse to decrease development time on upcoming projects. The software provides an efficient and effective structure for developing the test plans and sequencing for functional test of automotive ECMs. In fact, many measurements, tests and utilities are already provided as building blocks. Over 250 routines of the highest quality and provide maximum performance. A test engineering software team need only create the test plan and sequencing from these integral building blocks of software, add customization for the manufacturer's specific ECM serial commands and create any custom test and/or measurements.

Remove all doubt

Our repair and calibration services will get your equipment back to you, performing like new, when promised.

You will get full value out of your Agilent equipment throughout its lifetime.

Your equipment will be serviced by Agilent-trained technicians using the latest factory calibration procedures, automated repair diagnostics and genuine parts. You will always have the utmost confidence in your measurements.

Agilent offers a wide range of additional expert test and measurement services for your equipment, including initial start-up assistance onsite education and training, as well as design, system integration, and project management.

For more information on repair and calibration services, go to

www.agilent.com/find/removealldoubt



Agilent Email Updates

www.agilent.com/find/emailupdates

Get the latest information on the products and applications you select.



Agilent Direct

www.agilent.com/find/agilentdirect

Quickly choose and use your test equipment solutions with confidence.



www.agilent.com/find/open

Agilent Open simplifies the process of connecting and programming test systems to help engineers design, validate and manufacture electronic products. Agilent offers open connectivity for a broad range of system-ready instruments, open industry software, PC-standard I/O and global support, which are combined to more easily integrate test system development.



www.lxistandard.org

LXI is the LAN-based successor to GPIB, providing faster, more efficient connectivity. Agilent is a founding member of the LXI consortium.

www.agilent.com

For more information on Agilent Technologies' products, applications or services, please contact your local Agilent office. The complete list is available at:

www.agilent.com/find/contactus

Phone

Americas

Canada	(877) 894-4414
Latin America	305 269 7500
United States	(800) 829-4444

Asia Pacific

Australia	1 800 629 485
China	800 810 0189
Hong Kong	800 938 693
India	1 800 112 929
Japan	81 426 56 7832
Korea	080 769 0800
Malaysia	1 800 888 848
Singapore	1 800 375 8100
Taiwan	0800 047 866
Thailand	1 800 226 008

Europe

Austria	0820 87 44 11
Belgium	32 (0) 2 404 93 40
Denmark	45 70 13 15 15
Finland	358 (0) 10 855 2100
France	0825 010 700
Germany	01805 24 6333* *0.14€/minute
Ireland	1890 924 204
Italy	39 02 92 60 8484
Netherlands	31 (0) 20 547 2111
Spain	34 (91) 631 3300
Sweden	0200-88 22 55
Switzerland	(French) 44 (21) 8113811 (Opt 2)
Switzerland	(German) 0800 80 53 53 (Opt 1)
United Kingdom	44 (0) 7004 666666

Other European countries:

www.agilent.com/find/contactus

Revised: March 23, 2007

Product specifications and descriptions in this document subject to change without notice.

© Agilent Technologies, Inc. 2007

Printed in USA, June 28, 2007

5968-6784E



Agilent Technologies



Artisan Scientific

QUALITY INSTRUMENTATION ... GUARANTEED

Looking for more information?

Visit us on the web at <http://www.artisan-scientific.com> for more information:

- Price Quotations
- Drivers
- Technical Specifications, Manuals and Documentation

Artisan Scientific is Your Source for Quality New and Certified-Used/Pre-owned Equipment

- Tens of Thousands of In-Stock Items
- Hundreds of Manufacturers Supported
- Fast Shipping and Delivery
- Leasing / Monthly Rentals
- Equipment Demos
- Consignment

Service Center Repairs

Experienced Engineers and Technicians on staff in our State-of-the-art Full-Service In-House Service Center Facility

InstraView™ Remote Inspection

Remotely inspect equipment before purchasing with our Innovative InstraView™ website at <http://www.instraview.com>

We buy used equipment! We also offer credit for Buy-Backs and Trade-Ins

Sell your excess, underutilized, and idle used equipment. Contact one of our Customer Service Representatives today!

Talk to a live person: 888-88-SOURCE (888-887-6872) | Contact us by email: sales@artisan-scientific.com | Visit our website: <http://www.artisan-scientific.com>